

ROLLER SHADE

Installation Instructions

Spring Roller

BRACKET PLACEMENT:

To determine where to mount your brackets simply hold your roller shade up to the window (shade should be completely rolled up) in the desired location. With a pencil, make a mark where each "tip" of the roller lines up with the wall. The slot and the hole in the brackets should be placed over your mark.

MOUNT THE BRACKETS:

Standard Roll

(Fabric falls from back side of shade.)

1. Mount brackets in desired location. The slotted bracket is mounted on the left side.

Reverse Roll

(Fabric falls from front side of shade)

1. Mount brackets in desired location. The slotted bracket is mounted on the right side.

INSTALL THE SHADE:

1. Place the round pin in the bracket with the round hole and place the flat pin into the slotted bracket. (see fig. 1 for inside mount and fig. 2 for outside mount)

ADJUSTING TENSION ON THE SPRING ROLLER:

1. If you desire more tension, pull the shade down half way and remove from brackets. (see fig. 3)

2. Roll the shade up by hand. (see fig. 4)

3. Replace the shade into the brackets.

*If you have too much tension, remove the shade while it is in the up position and unroll half way by hand and replace the shade into the brackets. Note: too much tension may damage the roller.

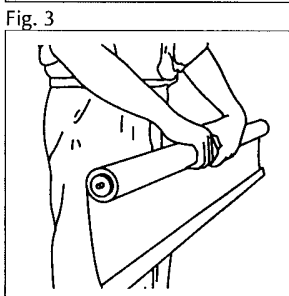
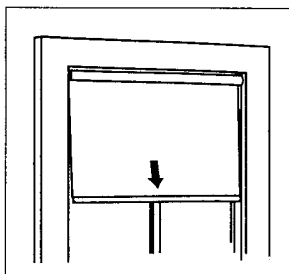
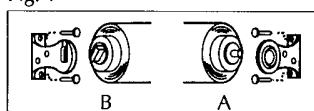
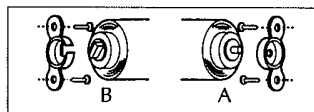
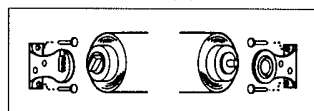
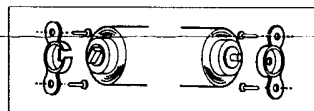

Fig. 4

Clutch Roller

MOUNT THE BRACKETS:

1. If the clutch is on the right end of the shade, attach the brackets to the window frame, window molding, wall or ceiling, as shown below. If the clutch is on the left end of the shade, reverse the bracket positions, left or right.

TO THE INSIDE OF THE WINDOW FRAME

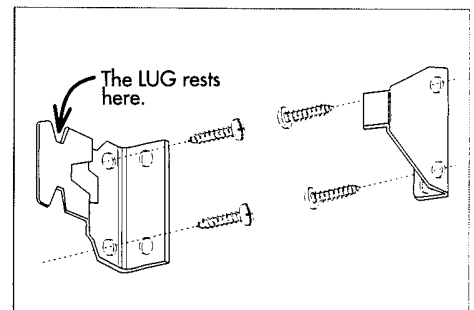

TO THE WALL OR TO THE FRONT OF THE WINDOW MOLDING

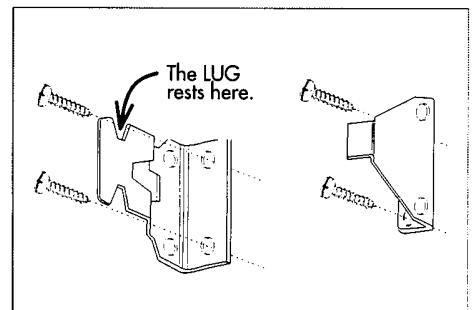

TO THE CEILING OR TO THE TOP OF THE WINDOW FRAME

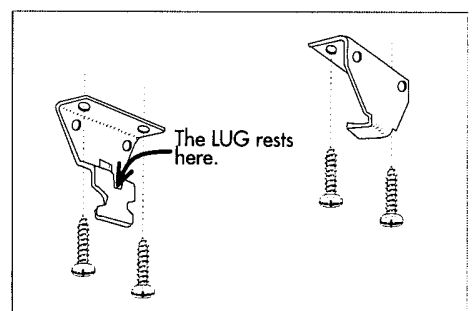

ROLLER SHADE

Installation Instructions

Clutch Roller Continued

INSTALL THE SHADE:

1. Push the clutch straight onto the blade of its bracket. The bottom of the clutch should always point straight down.
2. Lower the lug of the end plug onto the "V" of its bracket. The roller should fit in the brackets securely, with just a little play.

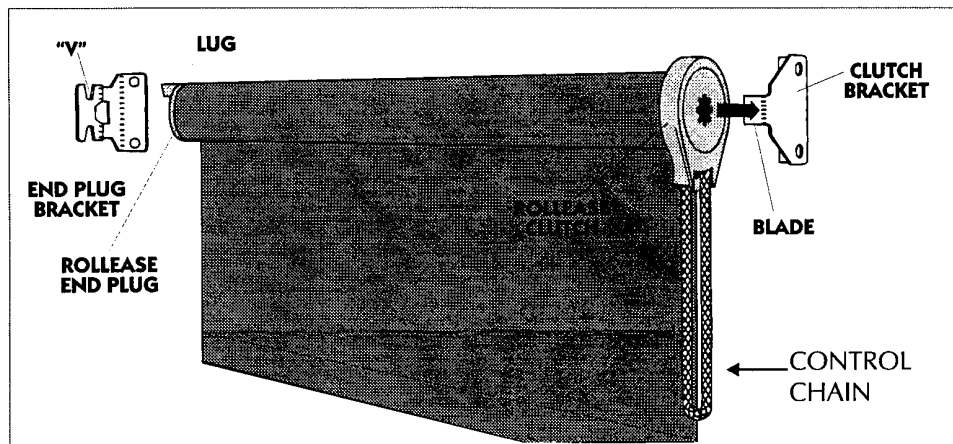

INSTALL THE TENSION DEVICE:

1. ANSI (American National Standards Institute) regulations require any cord or chain loop be secured to the wall to reduce the risk of possible injury to young children. To comply, this device must be used at the time of installation.

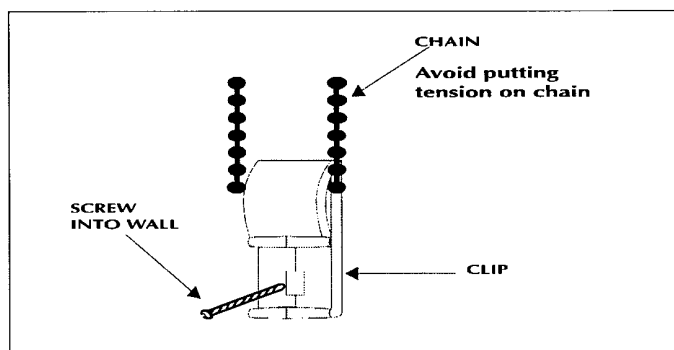

Fascia Panel

MOUNT THE BRACKETS:

1. The open end of each bracket faces downward, as shown in the drawing below. Note: If you have an inside mount and must use "inside mount holes", you will have to drill your own holes in the side of the bracket. Use at least two screws per bracket, and make sure that the screw heads clear the clutch.
2. Install the clutch straight onto the blade of its bracket. The bottom of the clutch should always point straight down, as shown below. Lower the lug of the end plug onto the "V" of its bracket. The roller should fit in the brackets securely, with just a little play.

